

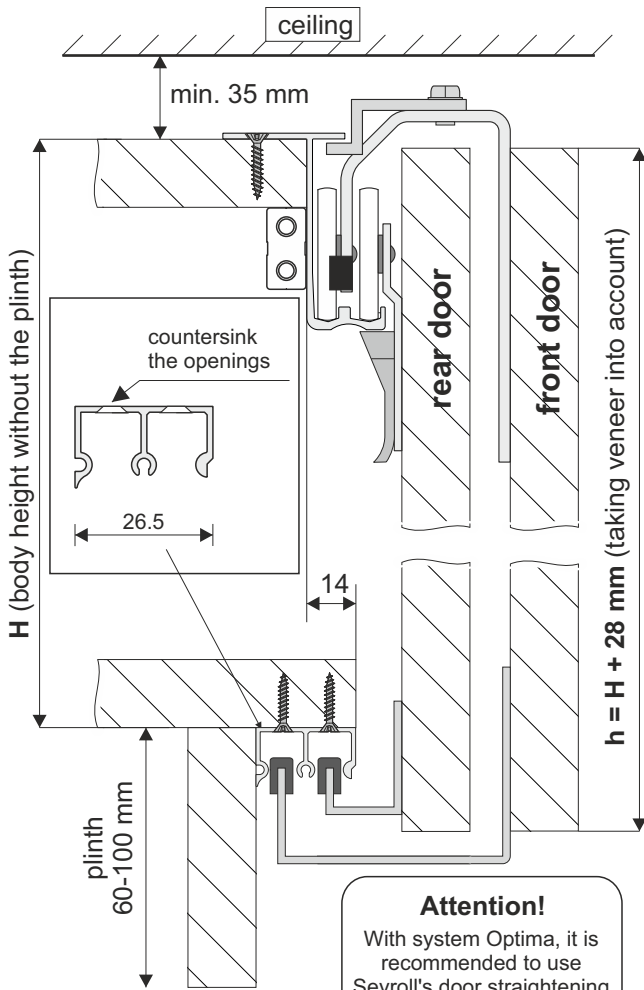

SYSTEM

OPTIMA 18 – for 3 wings



ATTENTION

Door height should be greater than body height (without the plinth) by exactly 28 mm.
 Top flange should be moved back by 13 mm in relation to the bottom flange and should be fastened firmly.
 Thickness of board: max. 20 mm.

Rear door assembly

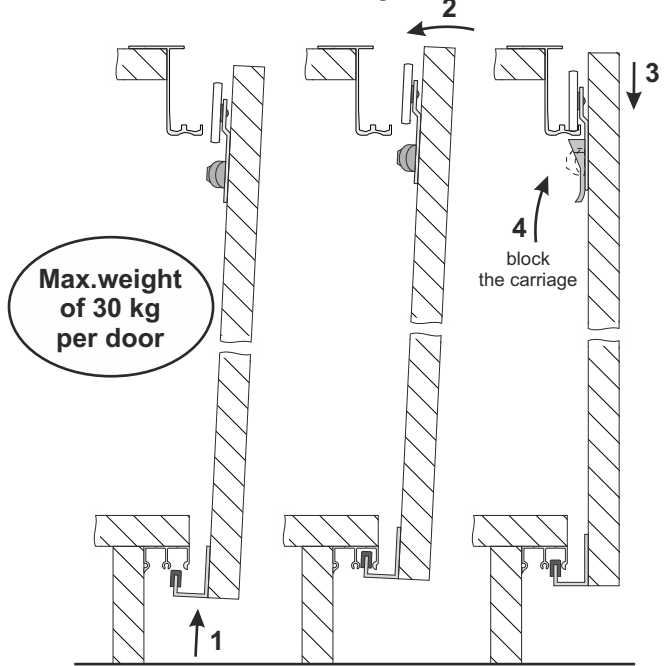

Attention!

With system Optima, it is recommended to use Sevroll's door straightening kits to eliminate the chance of door bowing

Front door assembly

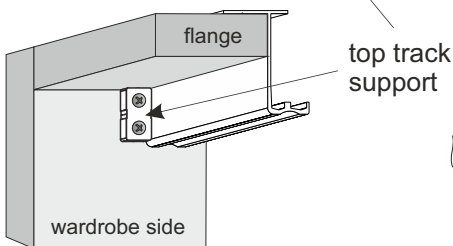
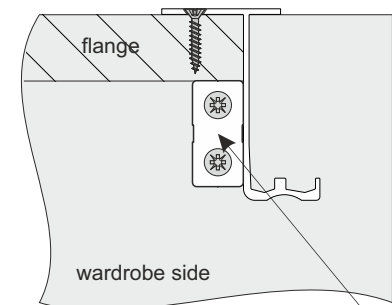
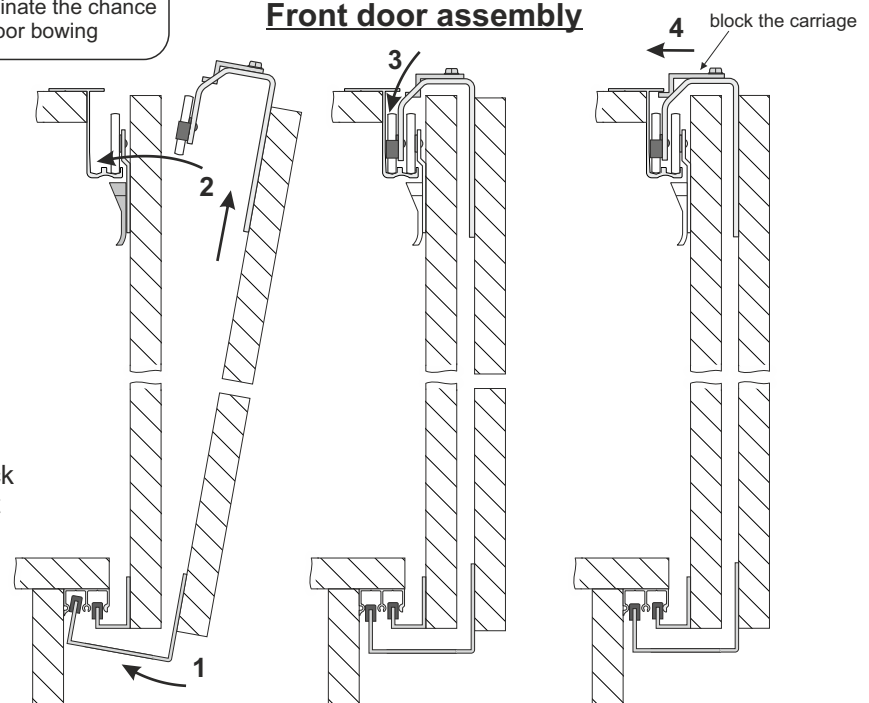

COMPONENTS

Top track Optima	Bottom track Optima	Set for sliding doors Optima II - 3 door wings	Handle Optima 18
L: 2.00 m, 2.40 m	L: 2.00 m, 2.40 m	2 door wings: x2, x1, x1, x2, x2, x2, x2	L: 2.40 m
		+ 1 door wing: x1, x1, x1	anti-dust brush inserted 14 x 4 mm (set A)
43	26		textile door stop inserted 4 x 4.8 mm (set A)
			#18



SYSTEM

OPTIMA 18 – for 3 wings



board width calculation

door without vertical proles (taking edging into account)

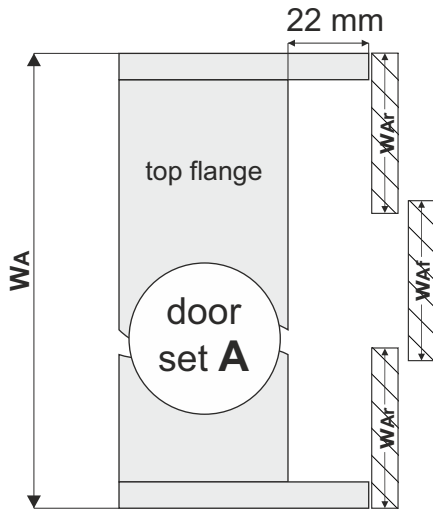

$$w_{Af} = w_{Ar} = (W_A + 40 \text{ mm}) : 3$$

door with vertical proles (handles)

rear door - 1 handle
front door - 2 handles

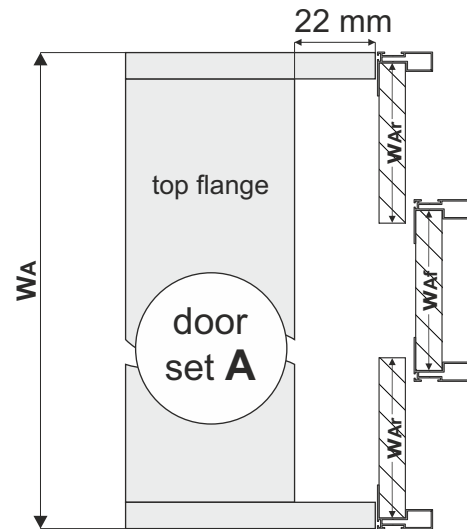

$$w_{Af} = [(W_A + 40 \text{ mm}) : 3] - 14$$

$$w_{Ar} = [(W_A + 40 \text{ mm}) : 3] - 7$$

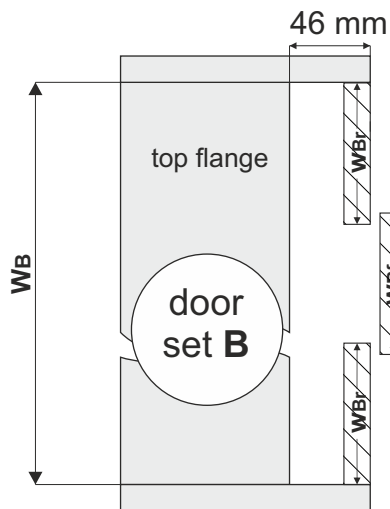

$$w_{Bf} = w_{Br} = (W_B + 40 \text{ mm}) : 3$$

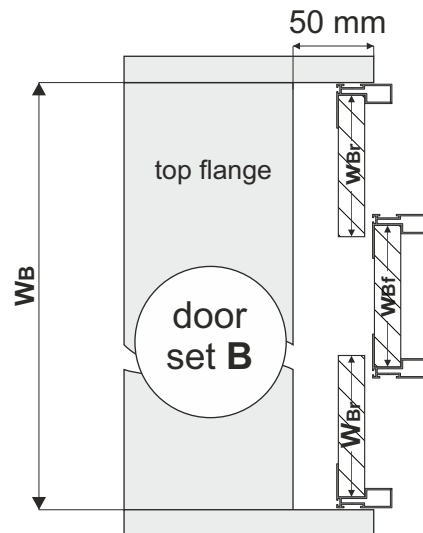

$$w_{Bf} = [(W_B + 40 \text{ mm}) : 3] - 14$$

$$w_{Br} = [(W_B + 40 \text{ mm}) : 3] - 7$$

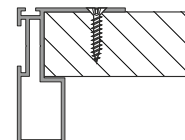

handle to be fastened with a minimum of 4 screws



SYSTEM

OPTIMA 18 – for 3 wings



Fastening of carriages and guides to the rear door

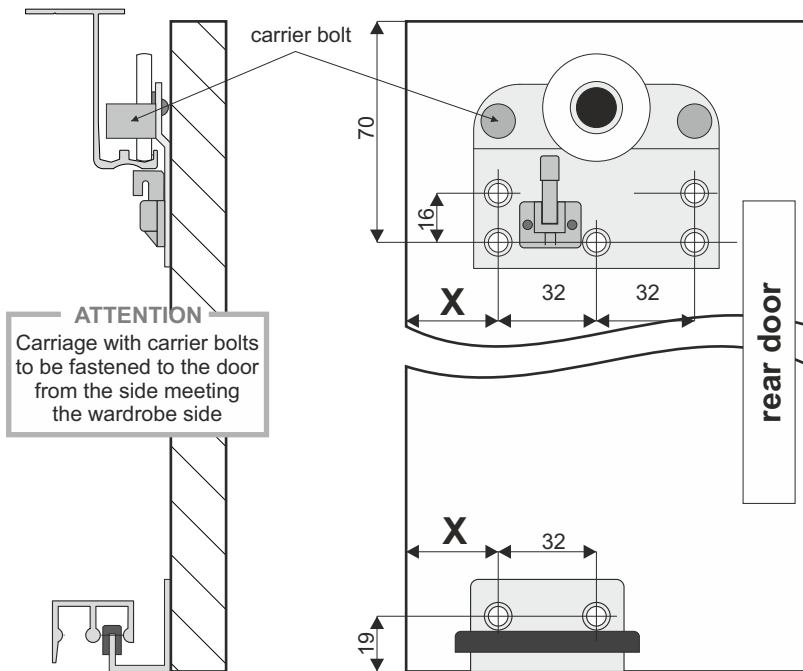

Fastening of stopper to the top track

rear door (set A and B)
door without and with vertical proles (handles)

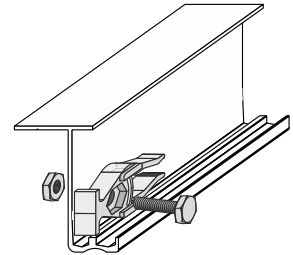

drill opening in track $\varnothing 6$

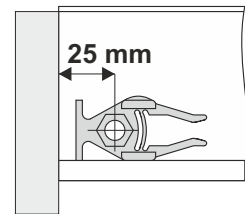

Fastening of carriages and guides to the front door

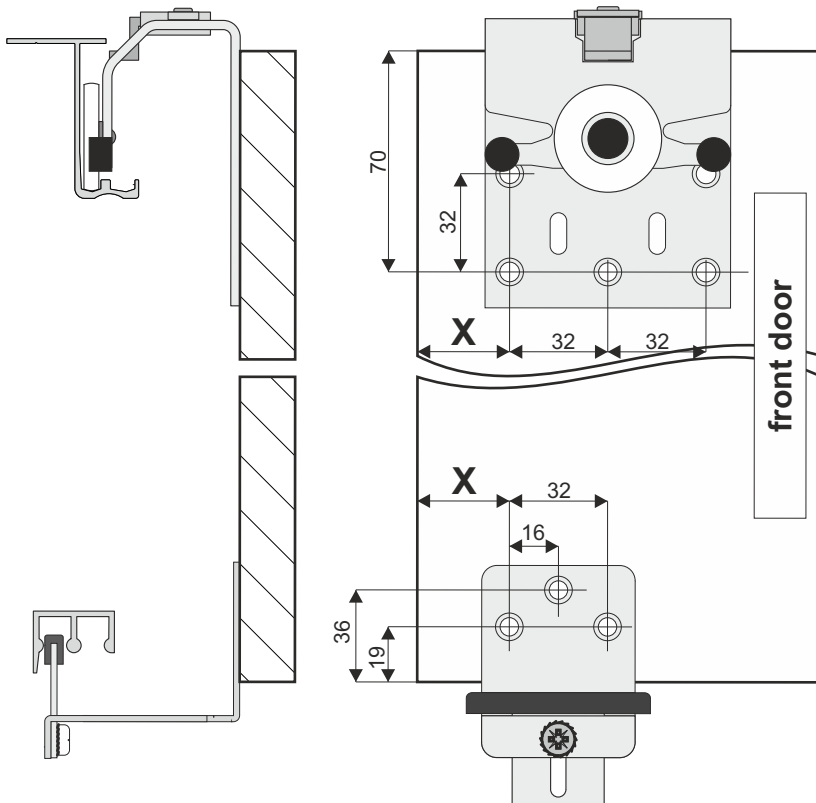

front door
(fasten after door assembly)

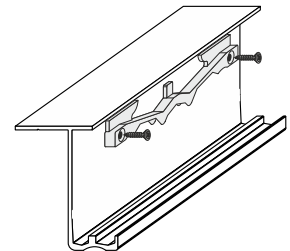

use self-tapping screw $\varnothing 3.5$
or drill opening in track $\varnothing 2.5$
and use Unix screw $\varnothing 3.5$

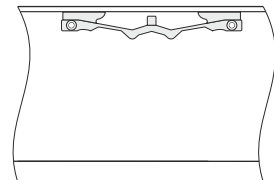

distance	door without vertical profiles		door with vertical profiles (handles)	
	door set A	door set B	door set A	door set B
X	58 mm	40 mm	51 mm	31 mm



Optionally, instead of stoppers, soft-closes **Optima** can be used purchased separately (only for rear door)