

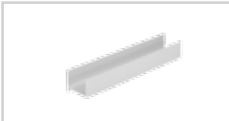



BASIC COMPONENTS OF LINE EDEN

PRODUCT	NAME	INDEX	COLOUR	LENGTH (MM)
	Horizontal profile EDEN XL	04725	SILVER	1700
		04723	RAL WHITE GLOSS	1700
		04726	SILVER	2350
		04724	RAL WHITE GLOSS	2350
		04688	SILVER	3000
	Top track EDEN	04689	RAL WHITE GLOSS	3000
		04715	SILVER	1700
		04717	RAL WHITE GLOSS	1700
		04716	SILVER	2350
		04718	RAL WHITE GLOSS	2350
	Bottom track GEMINI - Decor	04697	SILVER	3000
		04698	RAL WHITE GLOSS	3000
		04728	SILVER	6000
		04727	RAL WHITE GLOSS	6000
		00809	SILVER	1700
		04760	RAL WHITE GLOSS	1700
		00811	SILVER	2350
		04761	RAL WHITE GLOSS	2350
	Strengthening profile	00812	SREBRNY	3000
		04762	RAL WHITE GLOSS	3000
		01474	SREBRNY	4050
		04763	SILVER	4050
		02430	RAL WHITE GLOSS	6000
	Spacer profile 04	04764	SILVER	6000
		04318	RAL WHITE GLOSS	3000
	Masking profile EDEN	04319	SILVER	120
		04320	RAL WHITE GLOSS	120

EDEN SETS



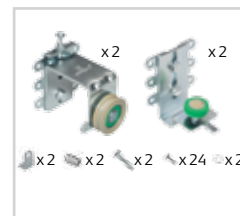
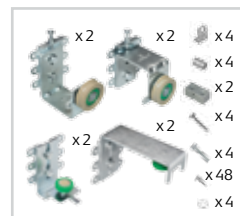



EDEN - a modern addition of simple elegance

Eden is a free-standing wardrobe system with concealed tracks. **Doors with frame construction allow the use of 4 mm glass without backing board.** System Eden offers two product lines: Pax and Pax XL.

Line PAX, polished edge glass bonded to the aluminium frame. This allows you to create designs with almost invisible aluminium frames. This solution works perfectly when using graphics on glass. To obtain the effect of a minimalist frame around the glass, select product line PAX XL. With PAX XL the glass does not require bonding to the profile. It is simply held using a special gasket.

Ball bearing carriage systems provide a smooth and quiet ride, all covered by a lifetime warranty. The height of doors can be adjusted and the system offers protection against running off the tracks. No visible base allows the doors to run very close to the floor. The special construction of this sliding system allows the doors to pass one another smoothly and effortlessly as their weight is supported solely by the bottom track. Guiding grooves that run along the horizontal profiles allow easy hole drilling for the screws, making the system easy to install. Comfort and high quality is ensured by adding optional soft-closers.

BASIC COMPONENTS OF LINE EDEN

PRODUCT	NAME	INDEX	COLOUR	LENGTH (MM)
	Handle PAX	04094	SILVER	2700
		04098	RAL WHITE GLOSS	2700
		04102	SILVER	3000
		04101	RAL WHITE GLOSS	3000
	Handle PAX XL	04414	SILVER	2700
		04416	RAL WHITE GLOSS	2700
		04415	SILVER	3000
		04417	RAL WHITE GLOSS	3000
	Gap filler PAX	20298	SILVER	-
		20299	RAL WHITE GLOSS	-
	Horizontal profile EDEN	04721	SILVER	1700
		04719	RAL WHITE GLOSS	1700
		04722	SILVER	2350
		04720	RAL WHITE GLOSS	2350
		04686	SILVER	3000
		04687	RAL WHITE GLOSS	3000

www.sevroll.com

SEVROLL
DOOR SYSTEMS AND FURNITURE ACCESSORIES

SYSTEM FOR SLIDING DOORS

NEW!

EDEN



The main advantages of line EDEN include:

- Concealed aluminium system
- Lack of traditional base
- Easy assembly
- Suitable for PAX and PAX XL line doors.

SEVROLL

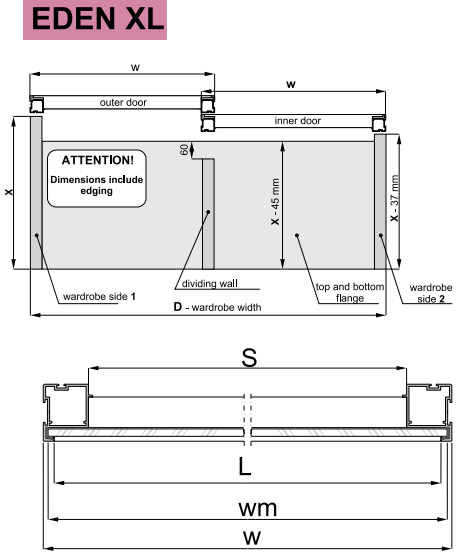
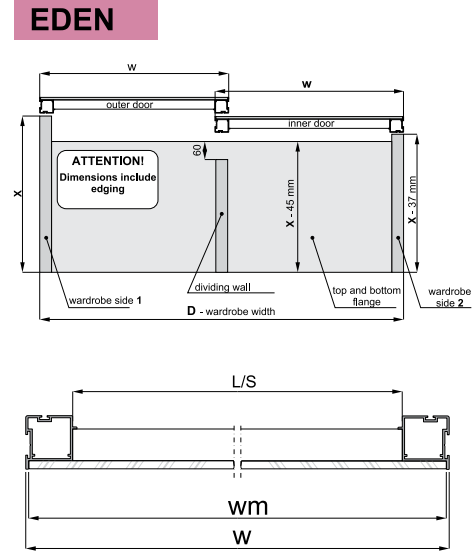
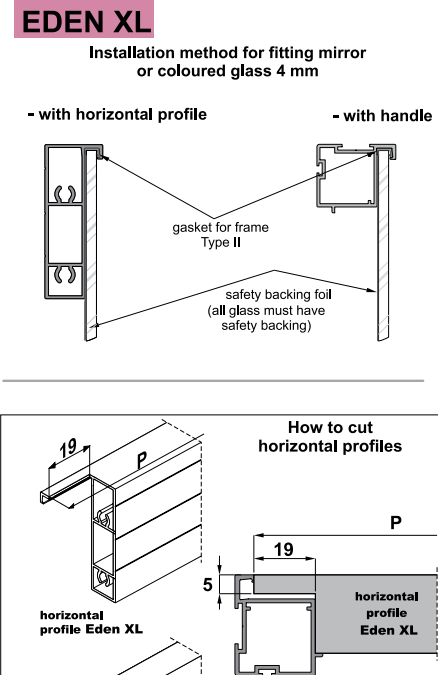
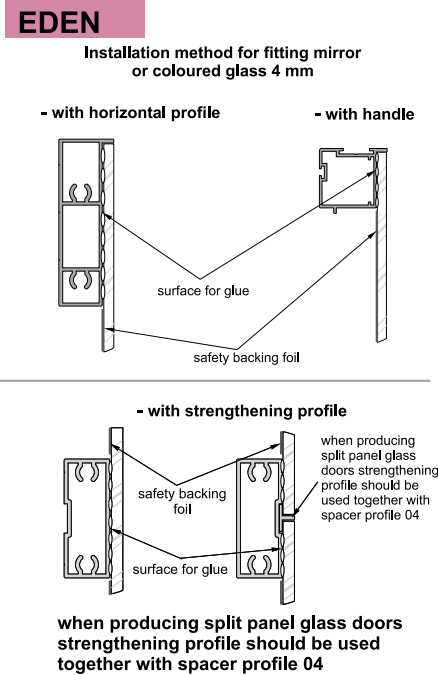
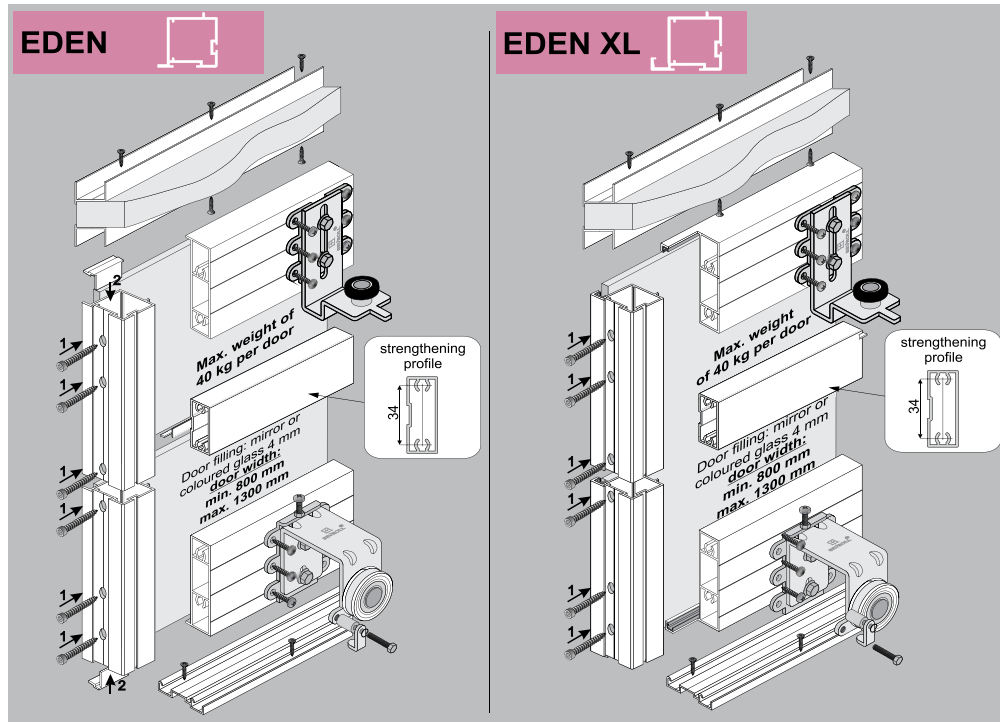

COMPONENTS EDEN

Handle Pax door brush inserted 4,8 x 6 mm Tactile door stop (optional) 14 x 4 mm	Gap filler Pax 8 pcs	Horizontal profile Eden	Set for sliding door Eden - 2 doors wings x2 x2 x2	Soft-close Sv25 MINI (index: 20359-SV) or Sv40 MINI (index: 20260-SV) x4
Bottom track Gemini	Top track Eden	(A) Strengthening profile Spacer profile 04 (B)	x4 x4 x2 screw 3.5x20 x4 screw M4x20 x4 self-tapping screw 3.9x13 x 48 spring washer 4 x4	

COMPONENTS EDEN XL

Handle Pax XL Anti-dust brush inserted 4,8 x 8 mm Tactile door stop (optional) 14 x 4 mm	Gasket for frame profile type II (index: 20167)	Horizontal profile Eden XL	Set for sliding door Eden - 2 doors wings x2 x2 x2	Soft-close Sv25 MINI (index: 20359-SV) or Sv40 MINI (index: 20260-SV) x4
Bottom track Gemini	Top track Eden	(A) Strengthening profile Spacer profile 04 (B)	x4 x4 x2 screw 3.5x20 x4 screw M4x20 x4 self-tapping screw 3.9x13 x 48 spring washer 4 x4	

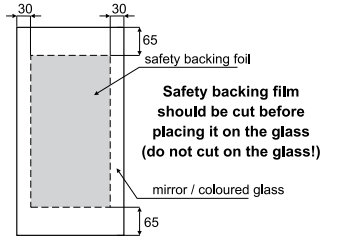
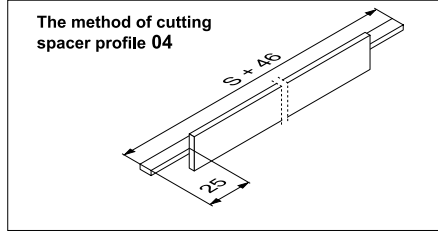

ATTENTION!

Rear mirror / coloured glass surface must be secured with safety backing foil (excluding glass surface glued with mirror adhesive). The edges of glass must be polished.

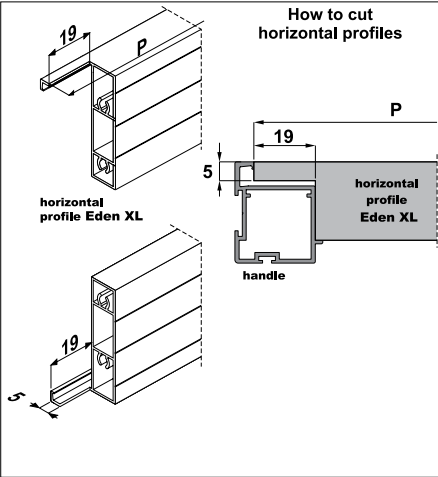

ATTENTION!

Rear mirror / coloured glass surface must be secured with safety backing foil (excluding glass surface glued with mirror adhesive). The edges of glass must be polished.

Door height - H

Door wing height - h h = H - 18 mm

Mirror height - hm hm = h - 4 mm

Door width w = (W + 25 mm) : 2

Mirror width wm = w - 4 mm

Horizontal profile Eden length - L L = S = w - 50 mm

Strengthening profile length - S S = w - 50 mm

Spacer profile 04 length S + 46 mm

Door height - H

Door wing height - h h = H - 18 mm

Mirror height - hm hm = h - 4 mm

Door width w = (W + 25 mm) : 2

Mirror width wm = w - 6 mm

Horizontal profile Eden XL length - L L = w - 12 mm

Strengthening profile length S = w - 50 mm

INFORMATION

