



LINE

DS Unicomfort / DS EXCLUSIVE

SYSTEM



Abide by the installation order

- 1 2 3 4

for all elements

- A B C

and profiles

- I II

Wardrobe front

Openings for top track fastening should be drilled at a distance of 26 mm from the edge of the wardrobe

26

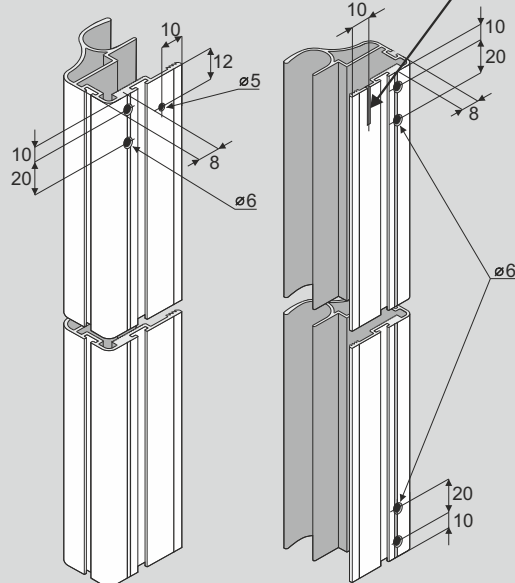
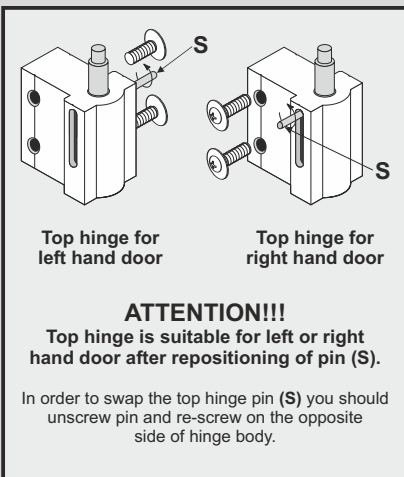
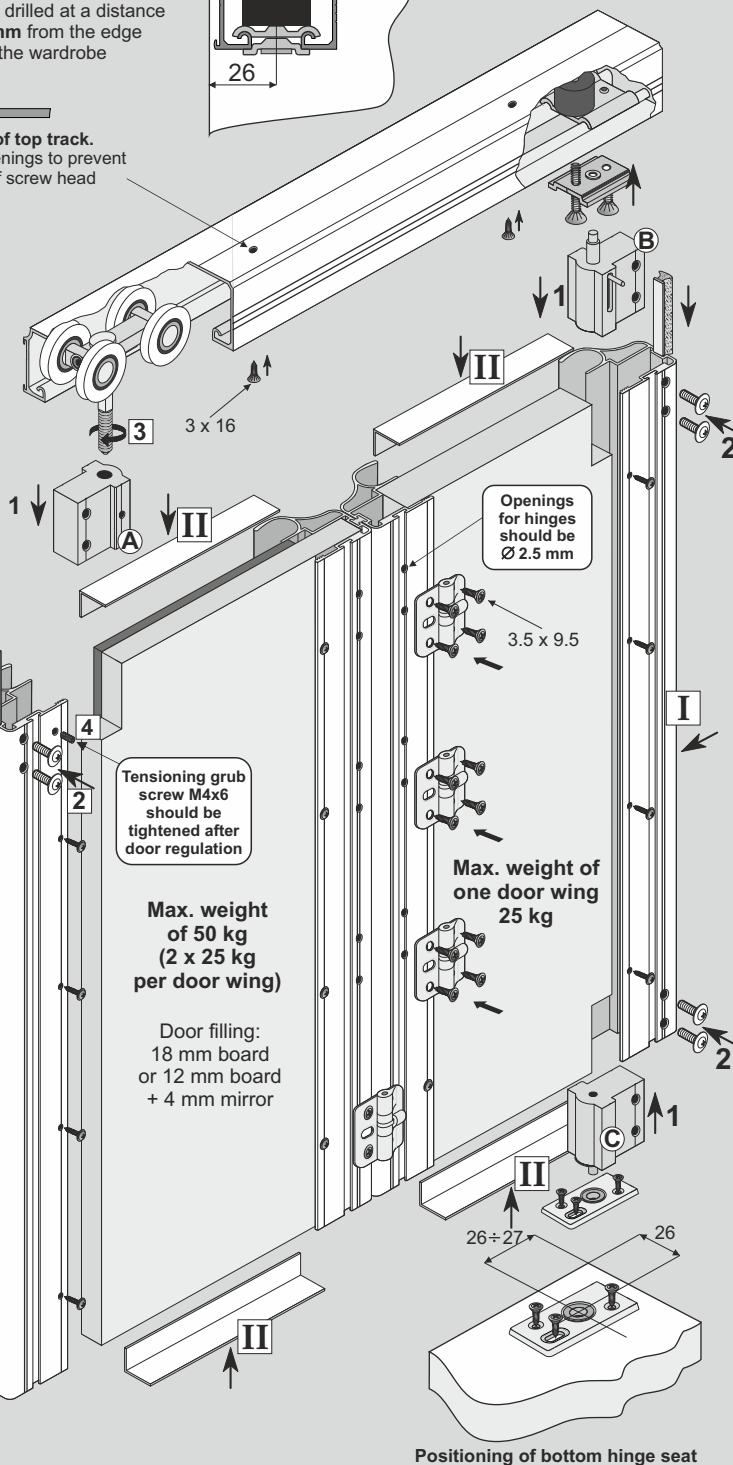
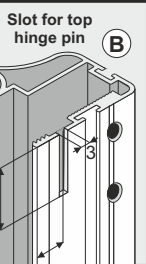
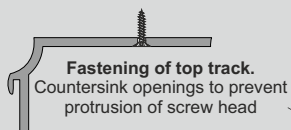

Openings spacing for fastening of top carriage body (A)

Openings spacing for fastening of top hinge and bottom hinge (C)

COMPONENTS

Handle Unicomfort II

L: 2.70 m

textile door stop inserted 4.8 mm x 6 mm

Top track Exclusive

L: 1.20 m, 1.80 m, 3.00 m, 3.60 m

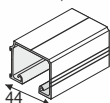

Angle section MINI or angle section ZW

L: 1.70 m, 2.35 m, 3.00 m

11 mm x 17 mm (board)
20 mm x 18 mm (mirror)

Set for folding doors ZSE-18 PLUS Unicomfort

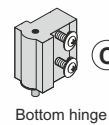
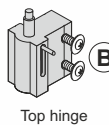
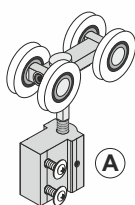

Self-tapping screw 3.5x9.5 (clip hange)	-16 pcs
Screw M4x6	-1 pc.
Screw 2.5x16 (handle)	-16 pcs
Screw 3.5x16 (bottom hinge seat)	-3 pcs
Screw 3x16 (track)	-6 pcs
allen key 2	-1 pc.





LINE

DS Unicomfort / DS EXCLUSIVE

SYSTEM



Dimensions of opening

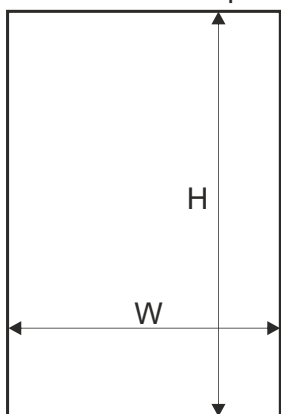

Handle length = door height = h

door height	- h	$h = H - 46 \text{ mm}$
board height	- hb	$hb = h - 3 \text{ mm}$
door width	- w	$w = (W - 8 \text{ mm}) : 2$
board width # 12 mm	- wb_{12}	$wb_{12} = w - 7 \text{ mm}$
board width # 18 mm	- wb_{18}	$wb_{18} = w - 40 \text{ mm}$
length of angle section* - L_w		determined after door construction

* - for doors constructed with board, use angle-section MINI 11 x 17
 - for doors constructed with mirror, use angle-section ZW 20 x 18

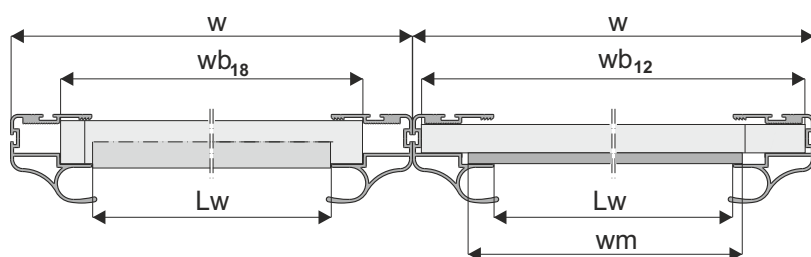

assembly adhesive (this is necessary when using mirror)

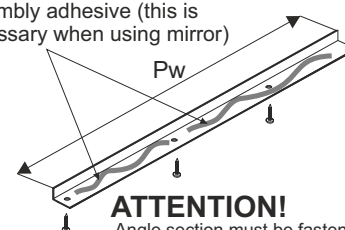
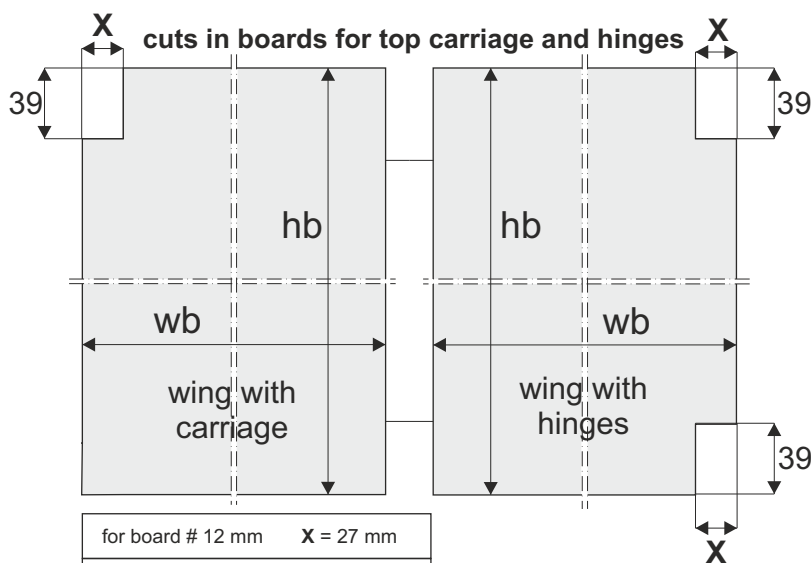
**ATTENTION!**Angle section must be fastened to board with minimum 3 screws $\varnothing 3 \times 25$.

for board # 12 mm X = 27 mm

for board # 18 mm X = 10 mm

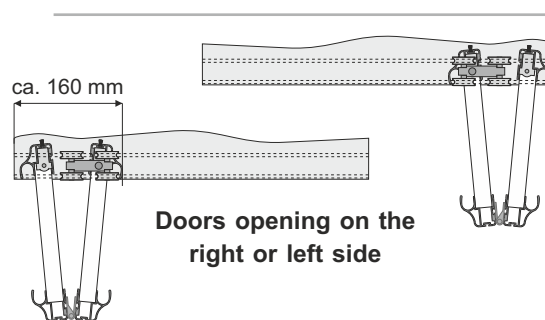

Four-winged doors require two sets

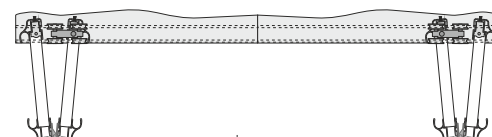

mirror dimensions

mirror height - $hm = hb - 4 \text{ mm}$ mirror width - $wm = wb_{12} - 47 \text{ mm}$ **ATTENTION:**

Board to mirror contact area should be free from dirt and grease before applying double-sided tape.

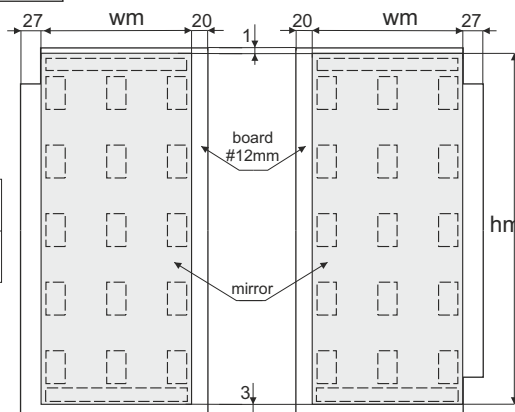

Broken line indicates recommended positioning of double-sided tape.

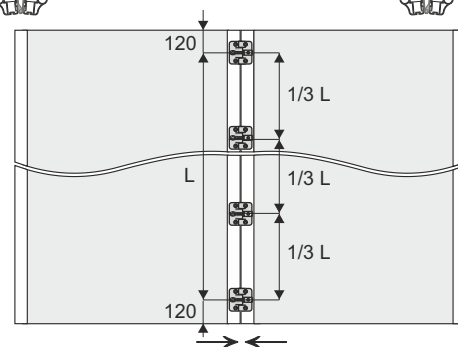

When fixing hinges, doors should be touching one another.
 Do not use textile door stop between the touching handles!

ATTENTION!

Remove protective film from aluminium elements (handles, tracks, connectors, etc.) prior to cutting them to the desired size. Film removal will reveal quality issues (eg. scratches)