



1 **2** **3**

Fastening of top track (countersink holes to prevent protrusion of screw head)

Positioner for top carriage FIX

self-tapping screw $\varnothing 6.3 \times 32$

$\varnothing 6.5$ $\varnothing 9.5$

handle-top 7

handle-bottom 41

8

Door filling: 10 mm board

Door filling: mirror 4 mm or safety glass 4.5 mm + gaskets

Max. weight of 50 kg per door

Installation of bottom track Gemini-Decor II using our mounting bush

Installation of bottom track using screws (countersink the openings)

Important dimension

for handles: 10-ka
Fox
Vitara
A = 24 mm, B = 21 mm

for handles: Gemini
Julia
Karat
Lynx
Romeo
A = 17 mm, B = 14 mm

ATTENTION:
In order to drill handle holes precisely and quickly, we recommend using our drill jig

index 20173

COMPONENTS

Handle					Lower horizontal profile Decor (A)	
L: 2.70 m					Upper horizontal profile Decor (B)	
10-ka	FOX	VITARA			L: 1.70 m	L: 1.70 m
					2.35 m	2.35 m
GEMINI	ROMEO	JULIA	KARAT	LYNX	3.00 m	3.00 m
Guiding carriage		Bottom carriage WD10C HI-TEC	Top track Gemini-Decor	Bottom track Gemini-Decor II		
10-ka or GEMINI						
			L: 1.70 m, 2.35 m, 3.00 m, 4.05 m, 6.00 m	L: 1.70 m, 2.35 m, 3.00 m, 4.05 m, 6.00 m		
			76 mm	53 mm		

Option: bottom track ELEGANT II

With Gemini 10 set you may use bottom track Elegant II with covering strip along with bottom carriage WD 10V HI-TEC. Fitting measurements are not affected.

Bottom carriage WD10V HI-TEC

Fastening of bottom track (special screw)

Stopper HI-TEC

You must remember to purchase self-tapping screws to construct each door (4 screws per door). When using safety glass, you must also remember to purchase gaskets.

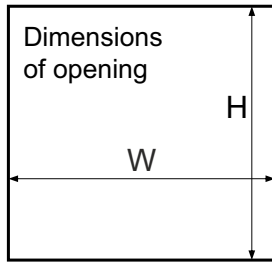

Handle length = door height					
LINE 10-ka		LINE FOX		LINE VITARA	
Handle 10-ka II anti-dust brush (inserted) 4.8 mm x 13 mm textile door stop (inserted) 14 mm x 4 mm	Guiding carriage 10-ka	Handle Fox II anti-dust brush (inserted) 4.8 mm x 13 mm textile door stop (inserted) 14 mm x 4 mm	Guiding carriage 10-ka	Handle Vitara anti-dust brush (inserted) 4.8 mm x 13 mm textile door stop (inserted) 14 mm x 4 mm	Guiding carriage 10-ka

door height - h	h = H - 40 mm		h = H - 40 mm		h = H - 40 mm	
door wing height with soft-close fitted	Mini SV25/40/60 SV-25/50	h = H - 40 mm	Mini SV25/40/60 SV-25/50	h = H - 40 mm	Mini SV25/40/60 SV-25/50	h = H - 40 mm
	Top SV60/80, Central SV25/40	h = H - 44 mm	Top SV60/80, Central SV25/40	h = H - 44 mm	Top SV60/80, Central SV25/40	h = H - 44 mm
board height - hb	hb = h - 64 mm		hb = h - 64 mm		hb = h - 64 mm	
door width - w	w = (W - 3 mm + Z) : N		w = (W - 3 mm + Z) : N		w = (W - 3 mm + Z) : N	
board width - wb	wb = w - 36 mm		wb = w - 20 mm		wb = w - 20 mm	
lower horizontal profile length - L	L = U = w - 53 mm		L = U = w - 37 mm		L = U = w - 36 mm	
upper horizontal profile length - U						
mirror height - hm	hm = bp		hm = hb		hm = hb	
mirror width - wm	wm = wb - 4 mm		wm = wb - 4 mm		wm = wb - 4 mm	

number of doors - N	2	3	4	5	2	3	4	5	2	3	4	5
total overlap - Z	35 mm	70 mm	105 mm	140 mm	36 mm	72 mm	108 mm	144 mm	20 mm	39 mm	59 mm	78 mm

visual design – 4 wings			
	$w = (W - 3 + 105) : 4$	$w = (W - 3 + 108) : 4$	$w = (W - 3 + 59) : 4$
	$w = (W : 2 + 32) : 2$	$w = (W : 2 + 33) : 2$	$w = (W : 2 + 17) : 2$

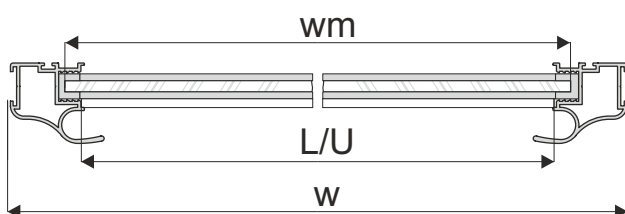
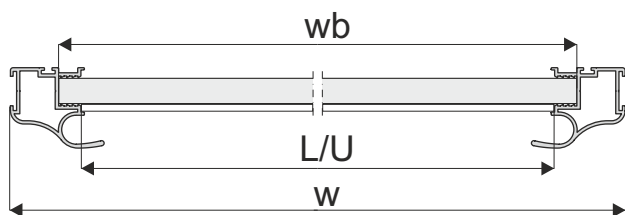

Installation method for fitting 10 mm board (diag. A) and 4 mm mirror or glass (diag. B)

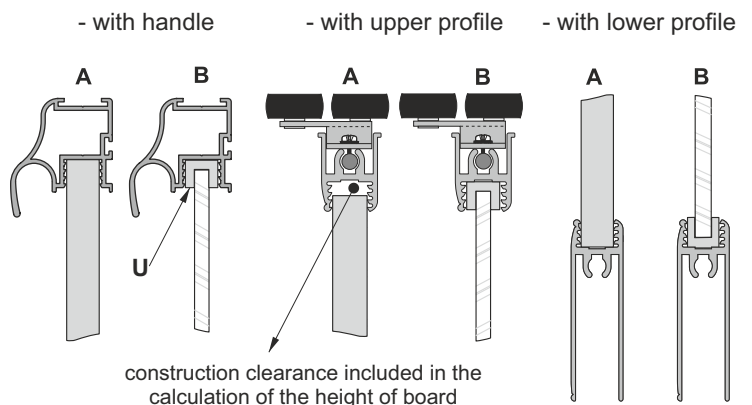





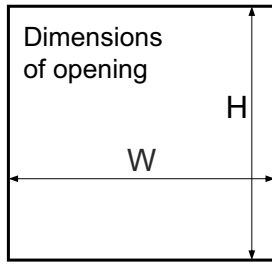

ATTENTION!

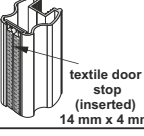
Mirror (4 mm) should be used with a safety backing film. Safety glass (4.5 mm) comprises of two thin layers with a film in-between. Both mirror and glass need fitting gaskets U.

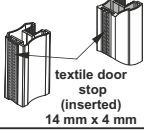
ATTENTION! Remove protective film from aluminium elements (handles, tracks, connectors, etc.) prior to cutting them to the desired size. Film removal will reveal quality issues (eg. scratches)

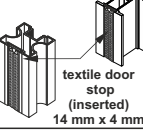

		Handle length = door height											
		LINE GEMINI				LINE JULIA/ROMEO				LINE KARAT/LYNX			
		Handle Gemini-Decor  textile door stop (inserted) 14 mm x 4 mm		Guiding carriage Gemini  L/P		Handle Julia II Handle Romeo II  textile door stop (inserted) 14 mm x 4 mm		Guiding carriage Gemini  L/P		Handle Karat Handle Lynx  textile door stop (inserted) 14 mm x 4 mm		Guiding carriage Gemini  L/P	
door height	- h	h = H - 40 mm				h = H - 40 mm				h = H - 40 mm			
door wing height with soft-close fitted		Mini SV25/40/60 SV-25/50	h = H - 40 mm		Mini SV25/40/60 SV-25/50	h = H - 40 mm		Mini SV25/40/60 SV-25/50	h = H - 40 mm		Mini SV25/40/60 SV-25/50	h = H - 40 mm	
		Top SV60/80, Central SV25/40	h = H - 44 mm		Top SV60/80, Central SV25/40	h = H - 44 mm		Top SV60/80, Central SV25/40	h = H - 44 mm		Top SV60/80, Central SV25/40	h = H - 44 mm	
board height	- hb	hb = h - 64 mm				hb = h - 64 mm				hb = h - 64 mm			
door width	- w	w = (W - 3 mm + Z) : N				w = (W - 3 mm + Z) : N				w = (W - 3 mm + Z) : N			
board width	- wb	wb = w - 46 mm				wb = w - 25 mm				wb = w - 41 mm			
lower horizontal profile length - L		L = U = w - 62 mm				L = U = w - 42 mm				L = U = w - 58 mm			
upper horizontal profile length - U													
mirror height	- hm	hm = bp				hm = hb				hm = hb			
mirror width	- wm	wm = wb - 4 mm				wm = wb - 4 mm				wm = wb - 4 mm			

number of doors	- N	2	3	4	5	2	3	4	5	2	3	4	5
total overlap	- Z	32 mm	64 mm	96 mm	128 mm	22 mm	44 mm	66 mm	88 mm	30 mm	60 mm	90 mm	120 mm

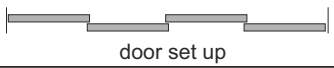
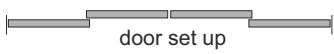
visual design – 4 wings				
	door set up	$w = (W - 3 + 96) : 4$	$w = (W - 3 + 66) : 4$	$w = (W - 3 + 90) : 4$
	door set up	$w = (W : 2 + 29) : 2$	$w = (W : 2 + 19) : 2$	$w = (W : 2 + 27) : 2$

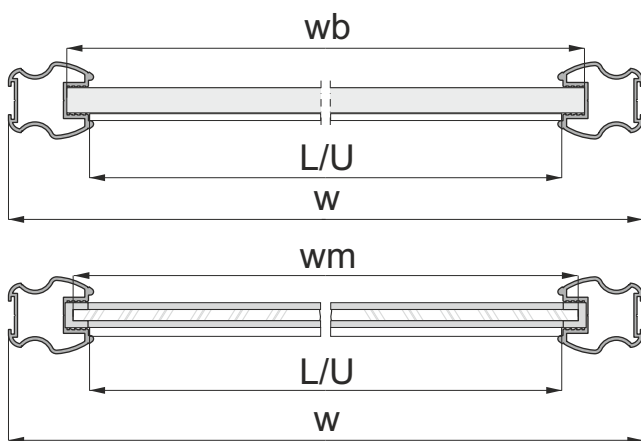

Installation method for fitting 10 mm board (diag. A) and 4 mm mirror or glass (diag. B)

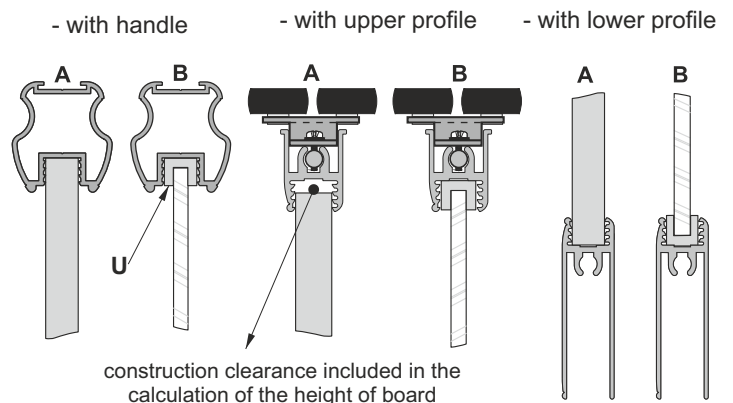

ATTENTION!

Mirror (4 mm) should be used with a safety backing film. Safety glass (4.5 mm) comprises of two thin layers with a film in-between. Both mirror and glass need fitting gaskets U.

ATTENTION! Remove protective film from aluminium elements (handles, tracks, connectors, etc.) prior to cutting them to the desired size. Film removal will reveal quality issues (eg. scratches)