



Soft-close for sliding doors

SEVROMATIC CENTRAL SV-25, SV-40



Assembly of soft-close mechanism with systems GEMINI 4, GEMINI 10, COMFORT 10, MAXIM 18

GEMINI 4, GEMINI 10, COMFORT 10

board height

$$h = H - 44 \text{ mm}$$

MAXIM 18

board height

$$h = H - 40 \text{ mm}$$

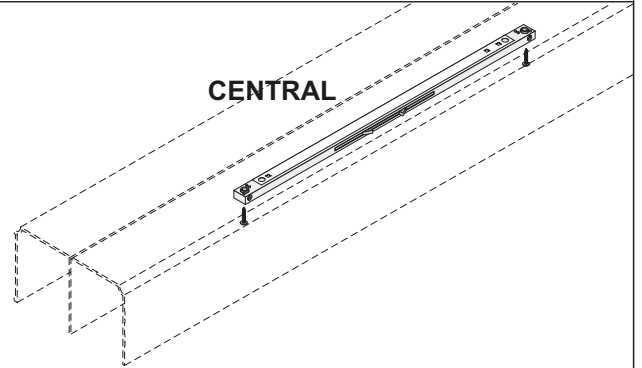
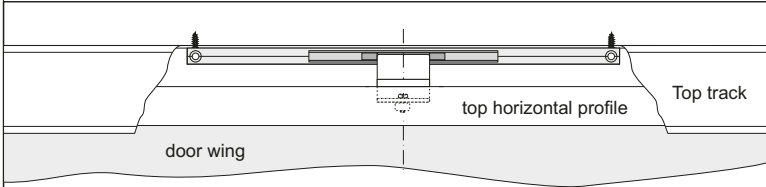

ATTENTION

Before fitting the door, remember to load the soft-close mechanism.

System GEMINI 4, GEMINI 10

symmetric guide

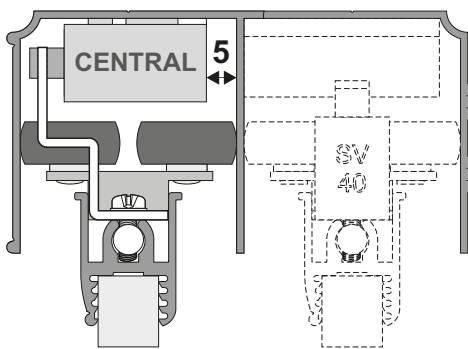

asymmetric guide

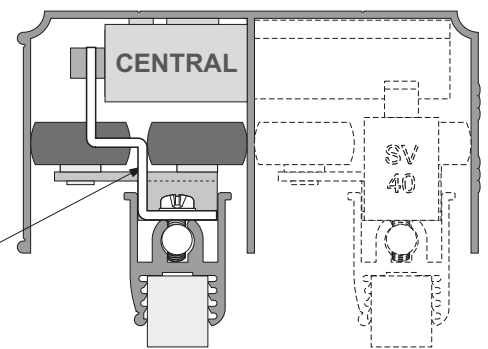
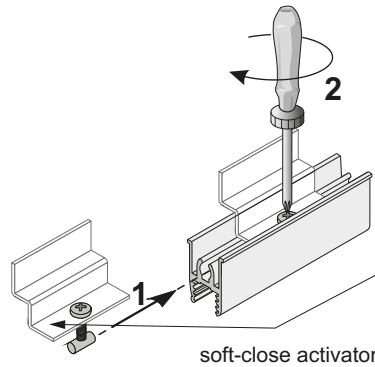

System COMFORT 10

symmetric guide

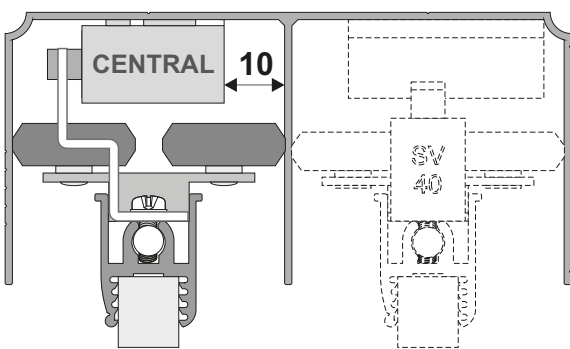

asymmetric guide

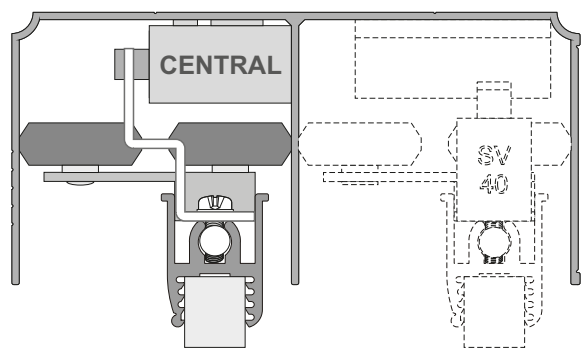

System MAXIM 18

symmetric guide

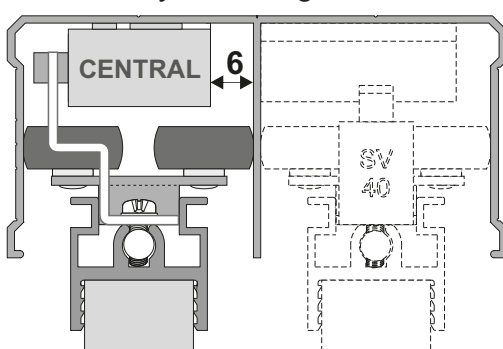

asymmetric guide

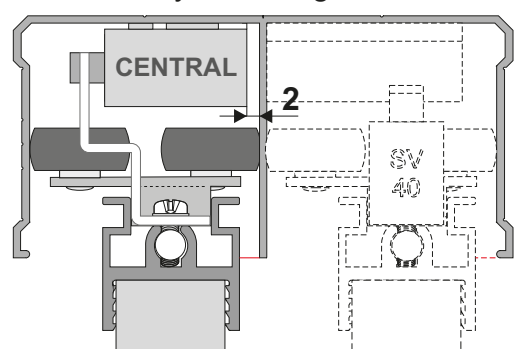



Soft-close for sliding doors

SEVROMATIC CENTRAL SV-25, SV-40



Assembly of soft-close mechanism with systems GEMINI 18, COMFORT 18, MAXIM 18 Board

GEMINI 18, COMFORT 18

board height

$$h = H - 44 \text{ mm}$$

MAXIM 18 Board

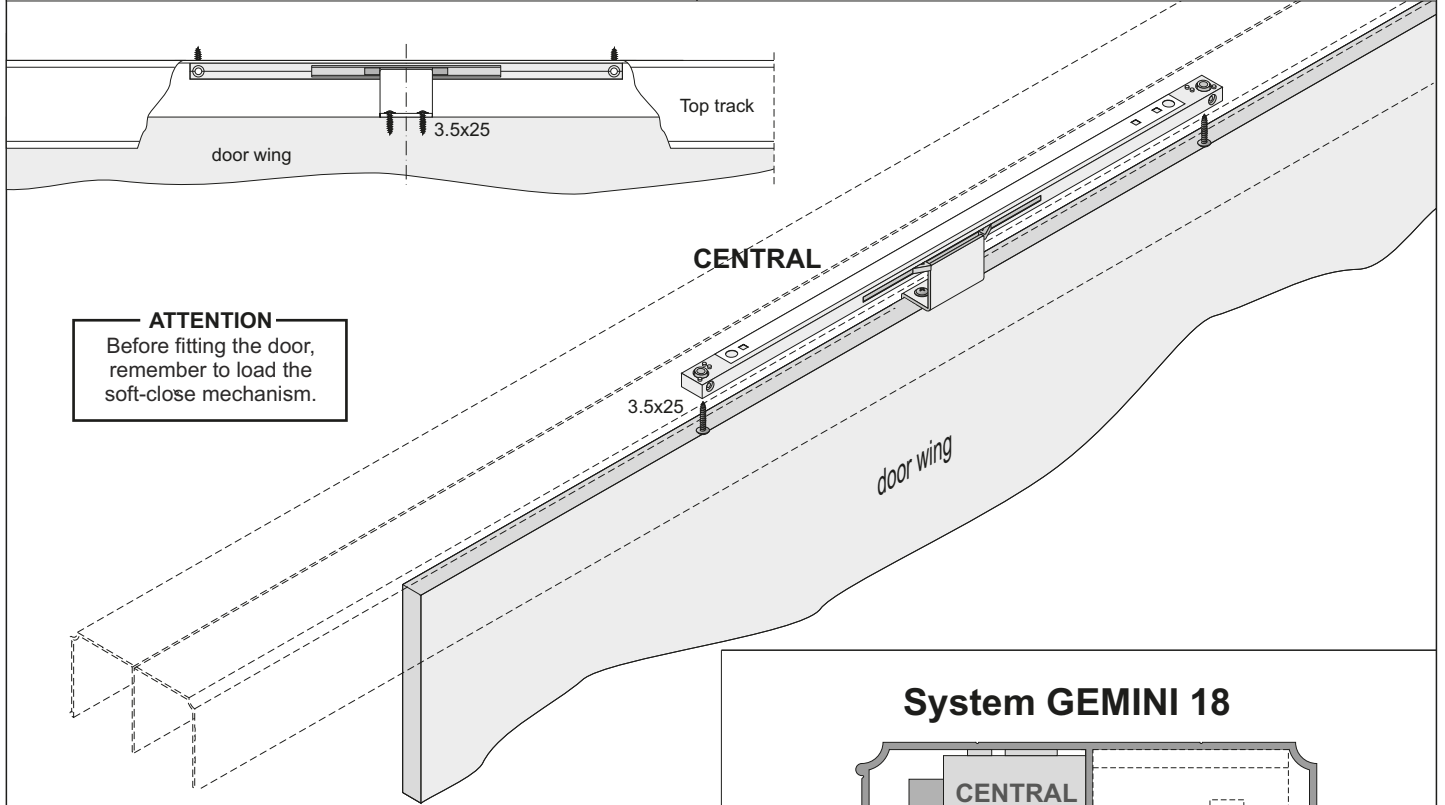

ATTENTION
Before fitting the door,
remember to load the
soft-close mechanism.

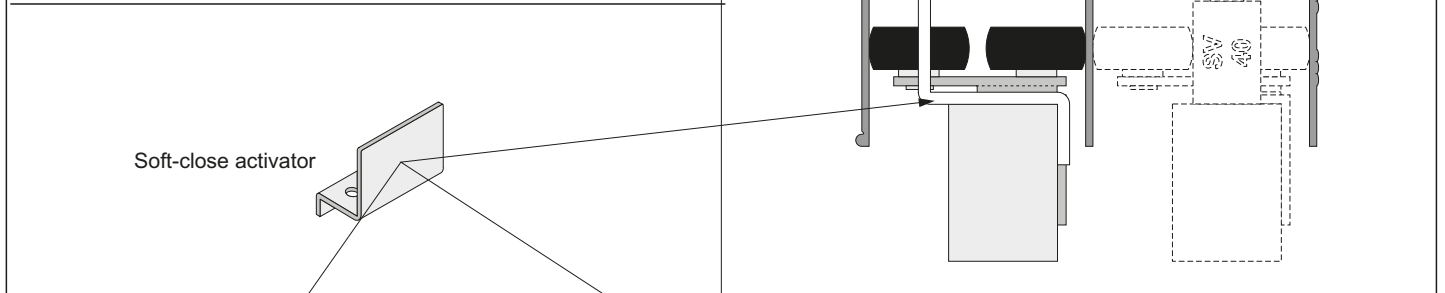

System GEMINI 18

Soft-close activator

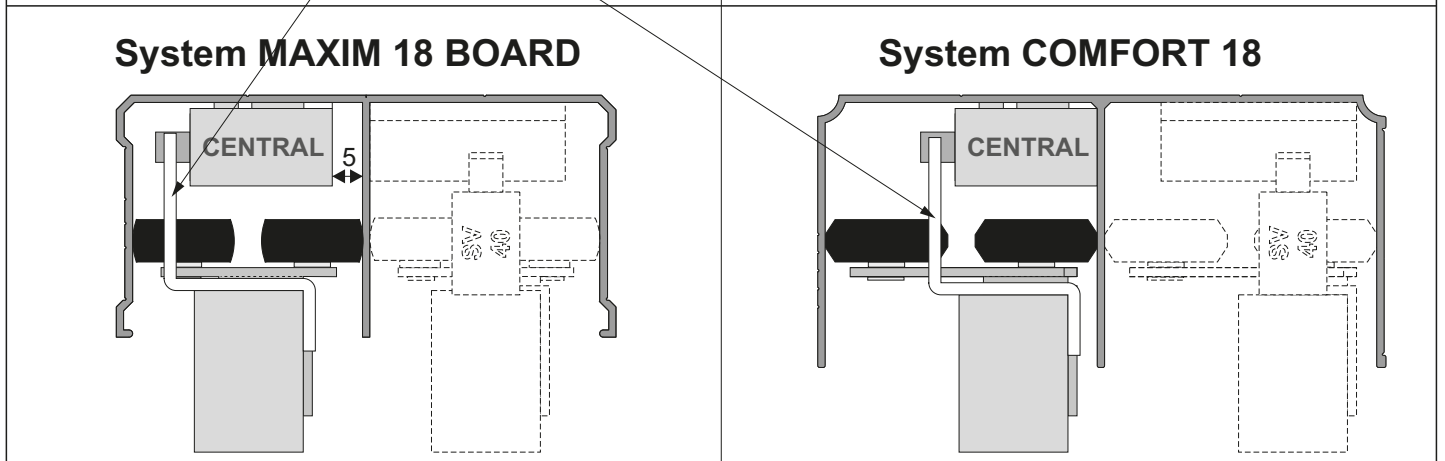





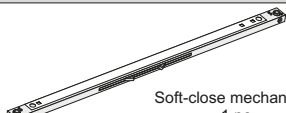

System MAXIM 18 BOARD

System COMFORT 18

COMPONENTS

Soft-close set for sliding doors Sevromatic CENTRAL SV-25 (25 kg) or SV-40 (40 kg)

- | | | | | | | |
|--|--|--|---|-------|---|--|
|  Soft-close mechanism - 1 pc. |  1 pc.
activator 10
CENTRAL | fastening pin - 1 pc. |  - 1 pc. | 1 pc. |  activator 18
CENTRAL | screw 3.5x25 - 4 pcs  |
| | | screw M3x8 - 1 pc.  | spring washer 3 - 1 pc.  | | | |