

COMPONENTS

<p>Handle</p> <p>L: 2.70 m</p> <p>GEMINI JULIA</p> <p>KARAT LYNX ROMEO</p>	<p>Lower horizontal profile Decor (A)</p> <p>Upper horizontal profile Decor (B)</p> <p>L: 1.70 m, 2.35 m, 3.00 m</p> <p>L: 1.70 m, 2.35 m, 3.00 m</p>	
<p>Top track SINGLE</p> <p>L: 1.70 m, 2.35 m, 3.00 m, 6.00 m</p> <p>38</p>	<p>Bottom carriage WD 10V HI-TEC</p>	<p>Guiding carriage GEMINI</p>

DEPENDENT ON FLOOR TYPE, YOU MAY CHOOSE FROM DIFFERENT BOTTOM TRACKS

<p>Bottom track HIDE M insert</p> <p>L: 1.70 m, 2.35 m, 3.00 m, 6.00 m</p>	<p>Bottom track HIDE G to be used with tiles</p> <p>L: 1.70 m, 2.35 m, 3.00 m, 6.00 m</p>	<p>Bottom track HIDE W II to be used with carpet</p> <p>L: 3.00 m, 6.00 m</p>
<p>Bottom track HIDE N surface mounted</p> <p>L: 1.70 m, 2.35 m, 3.00 m, 6.00 m</p>	<p>Track seat HIDE M</p> <p>L: 1.70 m, 2.35 m, 3.00 m, 6.00 m</p>	

You must remember to purchase self-tapping screws to construct each door (4 screws per door). When using safety glass, you must also remember to purchase gaskets.



LINE

JULIA, ROMEO, KARAT, LYNX, VITARA

SYSTEM





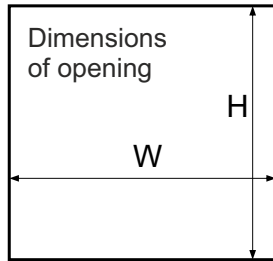

SINGLE 10

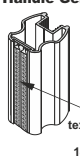

SEVROLL®

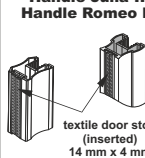

Handle length = door height

	LINE GEMINI		LINE JULIA / ROMEO		LINE KARAT / LYNX	
	Handle Gemini-Decor  textile door stop (inserted) 14 mm x 4 mm	Guiding carriage Gemini  L/R	Handle Julia II Handle Romeo II  textile door stop (inserted) 14 mm x 4 mm	Guiding carriage Gemini  L/R	Handle Karat Handle Lynx  textile door stop (inserted) 14 mm x 4 mm	Guiding carriage Gemini  L/R
Track HIDE N door height - h	h = H - 40 mm		h = H - 40 mm		h = H - 40 mm	
door wing height with soft-close fitted Track HIDE N	Mini SV25/40/60 SV-25/50	h = H - 40 mm	Mini SV25/40/60 SV-25/50	h = H - 40 mm	Mini SV25/40/60 SV-25/50	h = H - 40 mm
	Top SV60/80 Central SV25/40	h = H - 44 mm	Top SV60/80 Central SV25/40	h = H - 44 mm	Top SV60/80 Central SV25/40	h = H - 44 mm
Track HIDE W door height - h	h = H - 42 mm		h = H - 42 mm		h = H - 42 mm	
door wing height with soft-close fitted Track HIDE W	Mini SV25/40/60 SV-25/50	h = H - 42 mm	Mini SV25/40/60 SV-25/50	h = H - 42 mm	Mini SV25/40/60 SV-25/50	h = H - 42 mm
	Top SV60/80 Central SV25/40	h = H - 46 mm	Top SV60/80 Central SV25/40	h = H - 46 mm	Top SV60/80 Central SV25/40	h = H - 46 mm
Track HIDE: M, G , track seat Hide M door height - h	h = H - 35 mm		h = H - 35 mm		h = H - 35 mm	
door wingheight with soft-close fitted HIDE: M, G , track seat Hide M	Mini SV25/40/60 SV-25/50	h = H - 35 mm	Mini SV25/40/60 SV-25/50	h = H - 35 mm	Mini SV25/40/60 SV-25/50	h = H - 35 mm
	Top SV60/80 Central SV25/40	h = H - 39 mm	Top SV60/80 Central SV25/40	h = H - 39 mm	Top SV60/80 Central SV25/40	h = H - 39 mm
board height - hb	hb = h - 64 mm		hb = h - 64 mm		hb = h - 64 mm	
assumed door width	w		w		w	
board width - wb	wb = w - 46 mm		wb = w - 25 mm		wb = w - 41 mm	
lower horizontal profile length - L	L = U = w - 63 mm		L = U = w - 42 mm		L = U = w - 58 mm	
upper horizontal profile length - U						
mirror height - hm	hm = hb		hm = hb		hm = hb	
mirror width - wm	wm = wb - 4 mm		wm = wb - 4 mm		wm = wb - 4 mm	

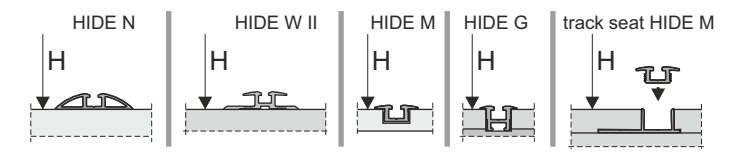
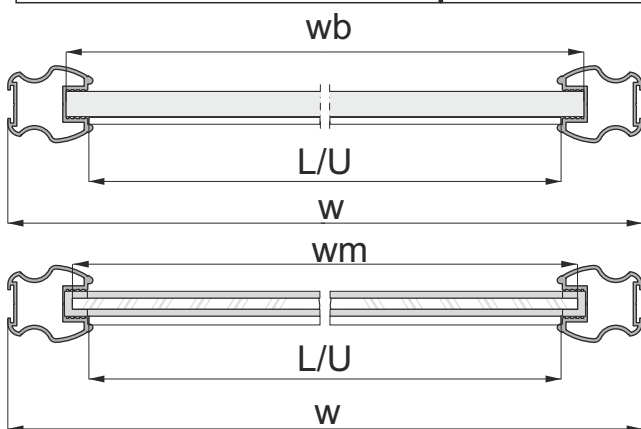

Installation method for fitting 10 mm board (diag. A)
and 4 mm mirror or glass (diag. B)

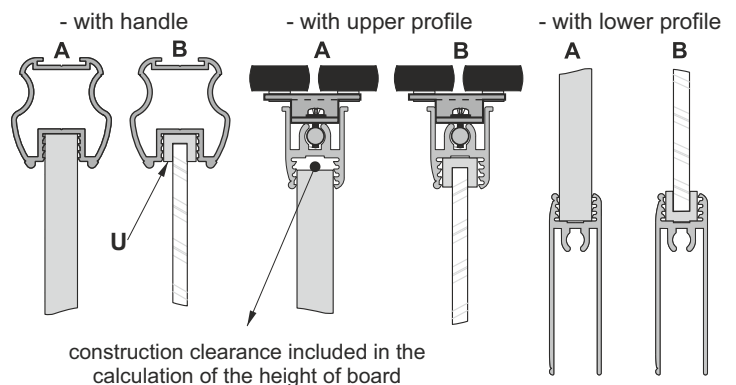
**ATTENTION!**

Mirror (4mm) should be used with a safety backing film. Safety glass (4.5 mm) comprises of two thin layers with a film in-between. Both mirror and glass need fitting gaskets U.

ATTENTION!

Remove protective film from aluminium elements (handles, tracks, connectors, etc.) prior to cutting them to the desired size. Film removal will reveal quality issues (eg. scratches)